

PRODUCT DATASHEET

IP65 Seiko aluminum - Street Light HYD-512-15W 6500K



Application

- Factory
- warehouse
- stadium
- Packing lots
- the farmer's market

Benefits

- Flicker free
- Protection against water & dust, IP65
- 90 degree focus to expand the irradiation range
- High light efficiency, to meet the needs of large factories of light, reduce workers in the production of errors

Features

- Clear Glass Lenses
- Warranty 5 years
- 6000K color temperature, suitable for people's visual feelings
- Aluminum thick, good heat dissipation performance and prolong service life

Electrical Data

Nominal wattage (W)	15W
Nominal Voltage (V)	220-240 V
Mains Frequency (Hz)	50
Nominal Current (mA)	79
LED Driver Current (mA)	270
LED Driver Voltage (Vdc)	17-54
LED Driver Efficiency (%)	88%
Power Factor λ	0.9
Total harmonic distortion (%)	20%
Operating mode	Built in LED driver

Photometrical data

Luminous flux $\pm 10\%$ (lm)	1932 lm
Luminous efficacy	125 lm/w
Color temperature	6500K
Light color (designation)	Cold White
Color rendering index Ra	≥ 80
Standard deviation of color matching	≤ 5 SDCM
Luminous intensity/cd	1082
Flickering	Flicker free
Beam angle	86 °

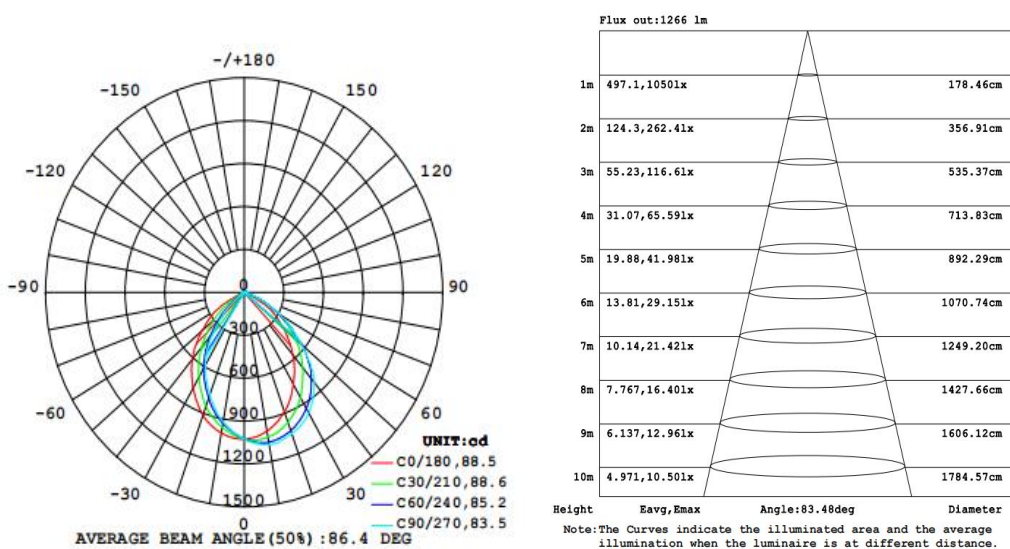

6500K

Dimensions & Weight

Diameter (mm)	488*185
Height (mm)	101
Product weight (g)	3306

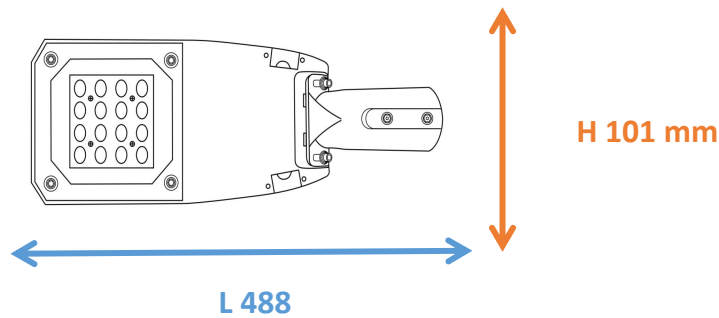

Material & Colors

Product color	Gray heat sink / Gray frame / Clear Glass
Housing color	Gray
Body material	Aluminum
LGP material	Glass
Mercury content	0.0 mg

Application & Mounting

Ambient temperature range	-40°C - +85 °C
Temperature range at storage	-40°C - +80 °C
Type of connection	Screwless terminal
Type of protection	IP65
Dimmable	No
Mounting type	Surface mounted/Suspended
Mounting location	Ceiling
Application environment	Indoor/Outdoor
Cut size (mm)	No
LED module replaceable	Not replaceable
With light source	Yes

Certificates & Lifespan

Life (h)	50,000
Certificates	CB CE LVD EMC
Standards	ISO9001:2015

Logistical Data

Product code	Dimensions (L*W*H)	Pcs/ carton	G.W. kg	Volume CBM
HYD-512-15W	58*26*16.5cm	1	...	0.02488 m ³

Installation Method

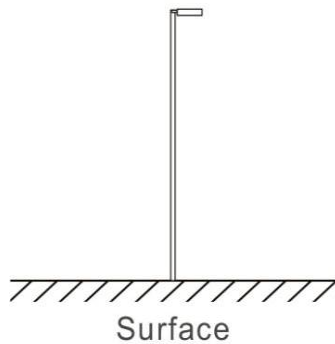

Disclaimer

Subject to change without notice. Errors and omission excepted. Always make sure to use the most recent release.