

## PRODUCT DATASHEET

**IP65+All PC+High luminous efficiency - Wall Light**  
**HYD-O1-20W 6500K**



---

### Application

- Villa
- Courtyard
- Doorway
- Balcony
- Corridor

---

### Benefits

- Flicker free
- Lighting coverage area is wide
- Protection against water & dust, IP65
- Low power, high light efficiency, energy saving and environmental protection

---

### Features

- Warranty 3 years
- All PC, Good light transmission
- High light transmission mask to ensure uniform light, reduce the dark area of the lighting environment

### Electrical Data

Nominal wattage (W)	<b>20W</b>
Nominal Voltage (V)	110-240 V
Mains Frequency (Hz)	50/60 Hz
Nominal Current (mA)	95
LED Driver Current (mA)	330
LED Driver Voltage (VDC)	60
LED Driver Efficiency (%)	85%
Power Factor $\lambda$	0.9
Operating mode	Built in LED driver

### Photometrical data

Luminous flux $\pm 10\%$ (lm)	2528
Luminous efficacy	124
Color temperature	<b>6500K</b>
Light color (designation)	Cold White
Color rendering index Ra	$\geq 80$
Standard deviation of color matching	$\leq 5$ SDCM
Luminous intensity/cd	739
Flickering	Flicker free
Beam angle	121 °

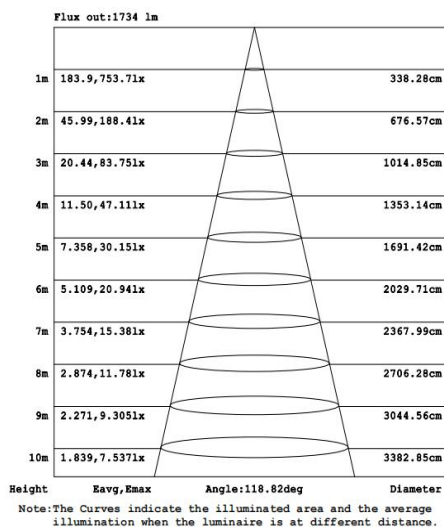
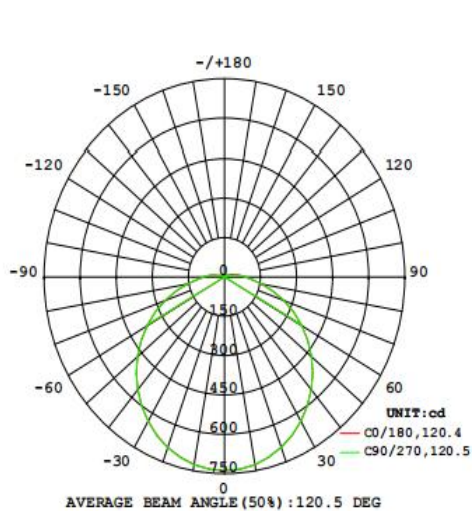

### Dimensions & Weight

Diameter (mm)	220
Height (mm)	66.5
Product weight (g)	420

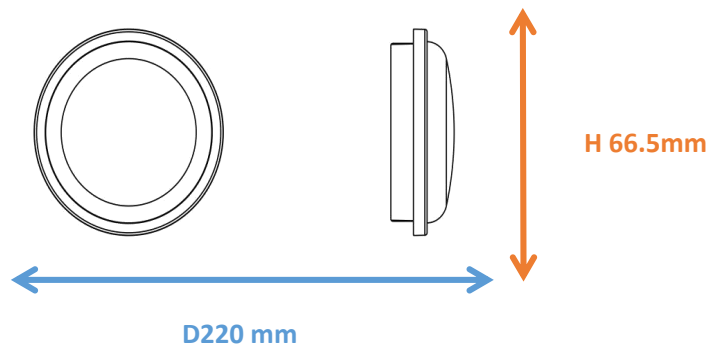

### Material & Colors

Product color	All White
Housing color	White
Body material	PC
Cover material	PC
Reflector color	White
Mercury content	0.0 mg

### Application & Mounting

Ambient temperature range	-30°C~+50 °C
Temperature range at storage	-40°C~+50 °C
Type of connection	Screw terminal
Type of protection	IP65
Dimmable	No
Mounting type	Surface mounted
Mounting location	Wall/Ceiling
Application environment	Indoor/Outdoor
Cut size (mm)	No
LED module replaceable	Not replaceable
With light source	Yes

## Certificates & Lifespan

Life (h)	30,000
Certificates	CB CE LVD EMC
Standards	ISO9001:2015

## Logistical Data

Product code	Dimensions (L*W*H)	Pcs/ carton	G.W. kg	Volume CBM
HYD-O1-20W	48*48*40 cm	20	...	0.09216 m <sup>3</sup>

## Installation Method

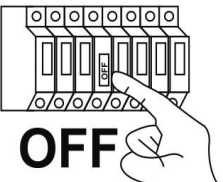
① 

**OFF**

②

Model	Product Size
HYD-O1-12W/3K, HYD-O1-12W/4K, HYD-O1-12W/6.5K	165x165x53mm
HYD-O1-20W/3K, HYD-O1-20W/4K, HYD-O1-20W/6.5K	220x220x67mm

③ Remove the Screws and the brace.

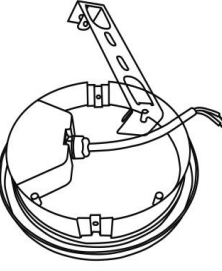

④ Attach the brace to the ceiling and connect the driver to the power wires.

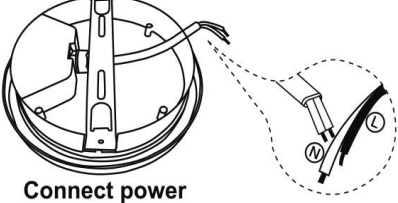

**Connect power**  
110-240V  
50/60Hz

⑤ The driver will be contained in the lighting fixture. Secure the brace inside the fixture by screws on both ends to finish installation.

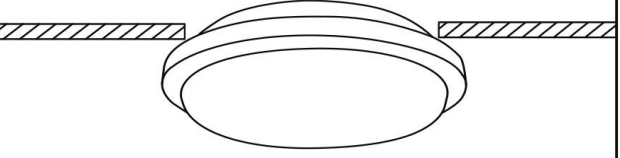

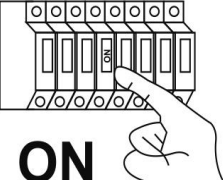
⑥ 

**ON**

## Disclaimer

Subject to change without notice. Errors and omission excepted. Always make sure to use the most recent release.